

Article number: 2310431051

Description: E+G Levelling elements  
LX.30-SW17-M6X22

## Measures

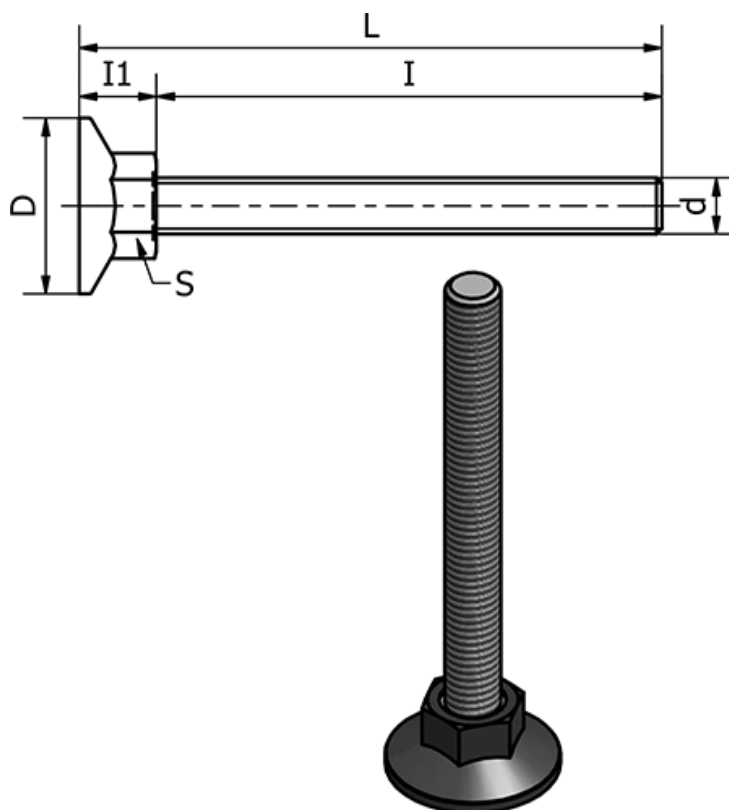

d	= M6
D	= 30
I	= 22
I1	= 12
L	= 34
S	= 17
Static load in (N)	= 1500
Type	= Forzinket

Weight (g) = -